

# False Caps, Risers & Starting Steps

## Oak Tread Caps

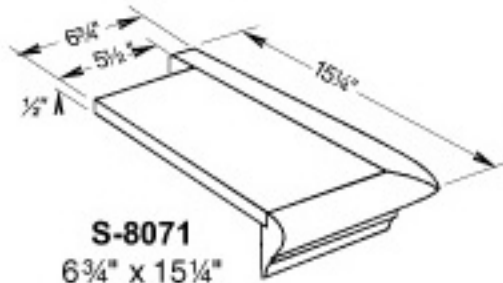

**S-8071**  
6 3/4" x 15 1/4"  
Oak Tread Cap with  
Mitered Return Nosing  
and Cove



**S-8072**  
5 1/4" x 13 3/4"  
Oak Tread Cap with  
Nosing and Cove

## Riser Caps

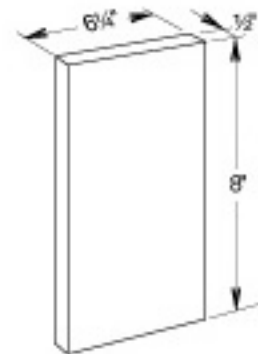

**S-8076**  
6 1/4" x 8"  
Riser Cap

Caps are 1/2" thick  
NOTE: Specify right or left hand.

NOT TO SCALE

## Starting Steps

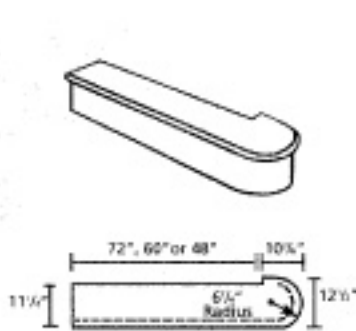

**S-8010**  
Starting Step  
Reversible  
Oak - 48", 60" or 72"  
Paint Grade - 48"  
Maple - 60"

**STOCK**

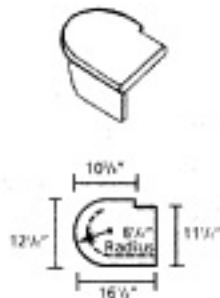

**S-8010-2**  
False Starting Step  
Reversible  
Grade or Maple

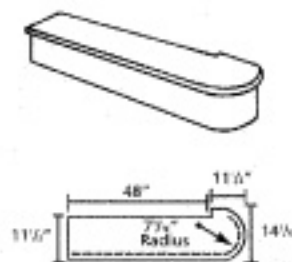

**S-8010**  
Starting Step  
Reversible  
48"  
Oak

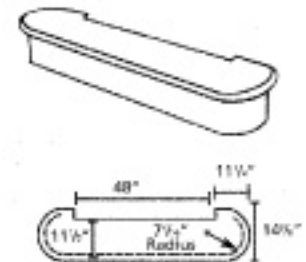

**S-8015**  
Starting Step  
Reversible  
48"  
Oak

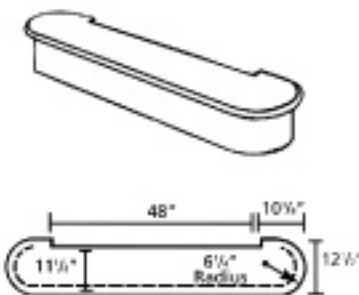

**S-8015**  
Starting Step  
48"  
Oak, Paint Grade or Maple

**STOCK**

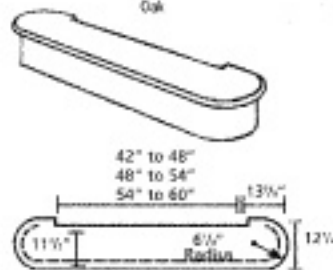

**S-8015 Adjustable**  
Starting Step  
Adjustable Size  
Width Options: 42" to 48", 48" to 54", 54" to 60"  
Oak

**STOCK**

The 8015 adjustable is trimable within a 6" range. Throat opening begins with smaller width but is trimable to larger widths. These steps are available with listed ranges.

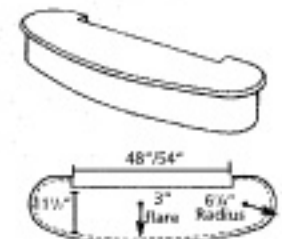

**S-8015B**  
Bowed Starting Step  
Adjustable  
Oak

**STOCK**

The bowed 8015 adjustable is trimable within a 6" range. Throat opening begins with smaller width but is trimable to larger width. One adjustable size available, 48"/54".

\* Non stock sizes and irregular shaped starting steps are available for quote.